

Power solutions. Worldwide.
Made in Germany. Since 1968.



SYMAP[®] Compact series

"One fits all" – Advanced digital protection
relay and grid power controller



- Reactive power undervoltage protection
- Independent overcurrent time-lag protection
- Network and system protection
- Power plant controller
- Distance protection (ANSI 21)



Overview

- stainless steel housing with aluminium front
- shallow depth – 90 mm depth incl. terminal plugs
- 3 status LEDs
- full colour touchscreen display
- remote display / detached HMI (optional)
- customizable menu screens
- multilingual HMI
- 8 programmable LEDs
- pluggable connections
- expandable with additional I/O boards
- USB connections as standard
- RS 485 with Modbus RTU as standard
- control and interlocking of up to 8 switching elements
- IEC: 61850, 60870-5-103, 104, Modbus RTU/TCP, Profibus DP, CANBUS
- up to 5 communication protocols can be used at the same time
- high-speed GOOSE
- 4 processors for ultimate reliability and speed

- self-diagnostic
- various protection functions included in standard version
- 4 independent protection setting groups
- independent and simultaneous protection for CT1 and CT2
- event-driven architecture system with powerful extension capabilities
- easy-to-use SYMAP®Compact parameter tool



Applications

SYMAP®Compact+ is a multifunctional protection relay for low, medium and high voltage applications. A touch screen, a wide range of protection functions, excellent software functions and hardware flexibility, up to 18

measurement inputs, a large number of binary inputs and outputs and high-speed GOOSE with all important communication protocols allows the use of SYMAP®Compact+ for any type of application.

Application guide (common)	LV	MV	HV	F1	F2	F3	F4	GC
Overcurrent protection	✓	✓	✓	✓	✓	✓	✓	✓
Differential protection	✓	✓				✓	✓	✓
Generator protection, control and monitoring	✓	✓				✓	✓	✓
Feeder protection, control and monitoring	✓	✓				✓	✓	✓
Transformer protection	✓	✓		✓	✓	✓	✓	✓
Motor protection	✓	✓		✓	✓	✓	✓	✓
Distance protection		✓				✓	✓	✓
Line differential protection	✓	✓		✓	✓	✓	✓	✓
Voltage and frequency protection	✓	✓	✓			✓	✓	✓
Synchro-check	✓	✓	✓				✓	✓
Automatic synchronization	✓	✓					✓	✓
Paralleling and protection	✓	✓					✓	✓
Advance AC & DC protection, monitoring and signal concentrator	✓	✓	✓			✓	✓	✓
Dynamic grid support	✓	✓				✓	✓	✓
RING protection and communication redundancy	✓	✓		✓	✓	✓	✓	✓
Protection for medium and low voltage soft starters	✓	✓		✓	✓	✓	✓	✓
GCP Generator control panel SYNC+P	✓	✓					✓	✓
Bay control	✓	✓	✓	✓	✓	✓	✓	✓
EZA/EZE (*) controller	✓	✓	✓					✓

(*) EZA & EZE active and reactive power controller & mains decoupling reg. grid code compliance
 EZA = power generation plant EZE = power generation unit LV = low voltage MV = medium voltage HV = high voltage

Grid Code Compliance:

- VDE-AR-N 4110:2018-11 / medium voltage (FGH certified)
- VDE-AR-N 4120:2018-11 / high voltage (FGH certified)
- G99

Hardware capabilities

Device variant	F1	F2	F3	F4	GC
Dimensions					
Housing dimensions (w × h × d) 210 × 250 × 87 mm	✓	✓	✓	✓	✓
Front plate dimensions (w × h × d) 210 × 250 × 4 mm	✓	✓	✓	✓	✓
Cutout (w × h) 192 × 232 mm	✓	✓	✓	✓	✓
LED indications					
3 status LEDs (trip: red, alarm: yellow, system: red/green)	✓	✓	✓	✓	✓
8 multicolour alarm LEDs with slide-in strips (optional with push buttons)	✓	✓	✓	✓	✓
Membrane keyboard					
6 membrane keys (up, down, key, ack, on, off)	✓	✓	✓	✓	✓
Display					
Graphic LC-display / touchscreen (320 × 240 pixel)	✓	✓	✓	✓	✓
Detached HMI	(✓)	(✓)	(✓)	(✓)	(✓)
Current measurement					
1 CT1 (3-phase, 0-32 xIn for HW v1-2.x)	✓	✓	✓	✓	✓
1 CT1-MP (separated measuring and protection CTs)	(✓)	(✓)	(✓)	(✓)	(✓)
1 CT2 (3-phase, 0-32 xIn for HW v1-2.x)	(✓)	(✓)	(✓)	(✓)	(✓)
1 CT-GND1 (1-phase, 1A / 5A / 2 ... 300 mA for HW 1-2.x)	✓	✓	✓	✓	✓
1 CT-GND2 (1-phase, 1A / 5A)	(✓)	(✓)	(✓)	(✓)	(✓)
Voltage measurement					
1 PT1 (3-phase, 0-1100V AC for HW1-2.x)			✓	✓	✓
1 PT2 (3-phase, 0-1100V AC for HW1-2.x)				✓	✓
1 PT3 (3-phase, 0-1100V AC for HW1-2.x)				✓	✓
1 PT-GND1 (1-phase: meas.)		✓	✓	✓	✓
Binary inputs					
18 pcs (24/48/60/110/220V DC, 110/230V AC) for HW v1-2.x	✓	✓	✓	✓	✓
Additional inputs possible with EBS-boards	(✓)	(✓)	(✓)	(✓)	(✓)
Binary outputs					
12 pcs (potential-free contacts, NO)	✓	✓	✓	✓	✓
Additional outputs possible with EBS-boards	(✓)	(✓)	(✓)	(✓)	(✓)
Analog inputs and outputs					
Up to 4 analog inputs and 5 analog outputs	(✓)	(✓)	(✓)	(✓)	(✓)
Communication interfaces					
1 Mini-USB (at side for device parameterization)	✓	✓	✓	✓	✓
1 RS485 (Modbus RTU)	✓	✓	✓	✓	✓
1 USB-A (on front plate, for parameter setting)	✓	✓	✓	✓	✓
1 CANBUS 0 Internal for detached HMI	(✓)	(✓)	(✓)	(✓)	(✓)
1 CANBUS 1	✓	✓	✓	✓	✓
1 CANBUS 2	(✓)	(✓)	(✓)	(✓)	(✓)
1 RJ45 for EBS and as serviceport/parameter setting	(✓)	(✓)	(✓)	(✓)	(✓)
1 RS485 for Profibus DP	(✓)	(✓)	(✓)	(✓)	(✓)
1 RJ45 or FO for IEC 61850, IEC 60870-5-104 and Modbus TCP	(✓)	(✓)	(✓)	(✓)	(✓)
2 RJ45 or FO for IEC 61850, IEC 60870-5-104 and Modbus TCP	(✓)	(✓)	(✓)	(✓)	(✓)
1 RS485 or FO for IEC 60870-5-103 or Modbus RTU (redundant)	(✓)	(✓)	(✓)	(✓)	(✓)
1 IIRIG-B	(✓)	(✓)	(✓)	(✓)	(✓)
1 line differential communication via FO for 2 km/20 km	(✓)	(✓)	(✓)	(✓)	(✓)

✓ Standard
(✓) Option

Protection functions

Device variant		F1	F2	F3	F4	GC
Protection functions (ANSI Code)						
21	Distance protection			(✓)	(✓)	(✓)
21B	Generator backup protection				✓	✓
21FL	Fault locator			✓	✓	✓
24	Overexcitation U/F			✓	✓	✓
25	Synchrocheck				✓	✓
25A	Automatic synchronisation				(✓)	✓
27	Undervoltage			✓	✓	✓
27Q	Reactive power/undervoltage			✓	✓	✓
27T	Undervoltage, time-dependent			✓	✓	✓
27/59TN	3rd Harm. stator-groundfault				✓	✓
32	Directional power			✓	✓	✓
32N/G	Zero power		✓	✓	✓	✓
37	Undercurrent	✓	✓	✓	✓	✓
40	Loss of field			✓	✓	✓
46	Negative phase sequence 12	✓	✓	✓	✓	✓
46BC	Negative phase sequence 12/11 (broken conductor)	✓	✓	✓	✓	✓
47	Phase sequence/phase balance			✓	✓	✓
48	Motor start up (incomplete sequence)	✓	✓	✓	✓	✓
49	Thermal replica	✓	✓	✓	✓	✓
49R	Thermal replica (rotor)	✓	✓	✓	✓	✓
50BF	Breaker failure	✓	✓	✓	✓	✓
50/51	Time overcurrent	✓	✓	✓	✓	✓
51LR	Locked rotor	✓	✓	✓	✓	✓
50/51G/N	Time ground overcurrent	✓	✓	✓	✓	✓
51/46VR	Overcurrent (voltage restrained)			✓	✓	✓
52	Pole discordance	✓	✓	✓	✓	✓
59	Overvoltage			✓	✓	✓
59AV	10 min overvoltage RMS protection			✓	✓	✓
59N/G	Neutral voltage displacement (NVD)		✓	✓	✓	✓
64REF	Restricted earth fault (REF)	✓	✓	✓	✓	✓
66	Start lock (motor)	✓	✓	✓	✓	✓
67	Directional time overcurrent			✓	✓	✓
67G/N/W	Directional time ground overcurrent		✓	✓	✓	✓
74TC	Trip circuit supervision	✓	✓	✓	✓	✓
78	Vector surge			✓	✓	✓
79	Automatic reclose (AR)	✓	✓	✓	✓	✓
81	Under-/overfrequency			✓	✓	✓
81R	RoCoF (df/dt)			✓	✓	✓
81RAV	Frequency supervised average (DF/DT)			✓	✓	✓
86	Lockout relay	✓	✓	✓	✓	✓
87	Transformer differential protection (2-winding only!)	(✓)	(✓)	(✓)	(✓)	(✓)
87LD	Line differential	(✓)	(✓)	(✓)	(✓)	(✓)
95i	Harmonics stabilizer	✓	✓	✓	✓	✓
G59/G99	(ANSI 78 and 81R acc. to British grid code)			✓	✓	✓
CLD	Cold load detection	✓	✓	✓	✓	✓
CTS	Current transformer supervision	✓	✓	✓	✓	✓
DCVM	DC voltage monitoring			✓	✓	✓
MSM	Motor state monitor	✓	✓	✓	✓	✓
PTS	Potential transformer supervision			✓	✓	✓
SOTF	Switch-on-to-fault	✓	✓	✓	✓	✓
TIG	Transient/intermittent ground fault protection		(✓)	(✓)	(✓)	(✓)
YG	Zero admittance ground fault protection		(✓)	(✓)	(✓)	(✓)

✓ Standard
(✓) Option

Software functions

Device variant	F1	F2	F3	F4	GC
Control and interlocking					
Control and interlocking for up to 8 switching elements	✓	✓	✓	✓	✓
Power management					
Generator control					✓
Measurement (indication)					
Current measurement values	✓	✓	✓	✓	✓
Voltage measurement values			✓	✓	✓
Frequency measurement values			✓	✓	✓
Power measurement values			✓	✓	✓
Energy measurement values			✓	✓	✓
Power factor values			✓	✓	✓
Min/Max current measuring values (statistic)	✓	✓	✓	✓	✓
Min/Max current measuring values - time range			✓	✓	✓
Recording functions					
Alarm control	✓	✓	✓	✓	✓
Active alarms/events	✓	✓	✓	✓	✓
Event recorder	✓	✓	✓	✓	✓
Fault recorder	✓	✓	✓	✓	✓
Disturbance recorder	✓	✓	✓	✓	✓
Counters					
Operating hours	✓	✓	✓	✓	✓
Energy counters			✓	✓	✓
Switching operations (breaker control)	✓	✓	✓	✓	✓
Monitoring functions					
Wire fault supervision: binary inputs	✓	✓	✓	✓	✓
Short circuit supervision: binary inputs	✓	✓	✓	✓	✓
LVM - limit value monitoring	✓	✓	✓	✓	✓
Logical functions					
PLC (programmable logic control)	✓	✓	✓	✓	✓
Graphical functions					
Configurable menu pages	✓	✓	✓	✓	✓
Vector representation of measuring values	✓	✓	✓	✓	✓
Representation of harmonics	✓	✓	✓	✓	✓
Synchroscope				✓	✓
Goose					
128 virtual inputs	(✓)	(✓)	(✓)	(✓)	(✓)
128 virtual outputs	(✓)	(✓)	(✓)	(✓)	(✓)
Security					
User-level/role-based security access	✓	✓	✓	✓	✓
Password-protected access by HMI	✓	✓	✓	✓	✓
Parameter for blocking settings change over Ethernet	✓	✓	✓	✓	✓
Ethernet service port for isolated access	✓	✓	✓	✓	✓
Network protocols and time synchronisation					
RSTP (rapid spanning tree protocol)	(✓)	(✓)	(✓)	(✓)	(✓)
HSR (high-availability seamless redundancy), IEC 62439-3	(✓)	(✓)	(✓)	(✓)	(✓)
PRP (parallel redundancy protocol), IEC 62439-3	(✓)	(✓)	(✓)	(✓)	(✓)
SNTP (simple network time protocol)	(✓)	(✓)	(✓)	(✓)	(✓)
PTP (precision time protocol)	(✓)	(✓)	(✓)	(✓)	(✓)
IRIG-B (inter-range instrumentation group)	(✓)	(✓)	(✓)	(✓)	(✓)
Hot standby-dual-homing	(✓)	(✓)	(✓)	(✓)	(✓)

✓ Standard
 (✓) Option

HMI

SYMAP®Compact+ HMI is highly customizable and user-friendly.

Display:

- large full colour touchscreen with user-friendly interface
- user-defined function keys
- 4 configurable user pages: single line, measurement indications, text, buttons, bar graphs, graphics, configurable background, graphic elements, button colour, page links ...
- adjustable parameters via HMI
- password-protected access and user-level role

Keys:

- Keys on touchscreen and front plate

LEDs:

Standard device:

- 8 programmable LEDs (optional with push buttons)
- 3 status LEDs (system and user-programmable status)
- graphical, programmable LEDs on touchscreen

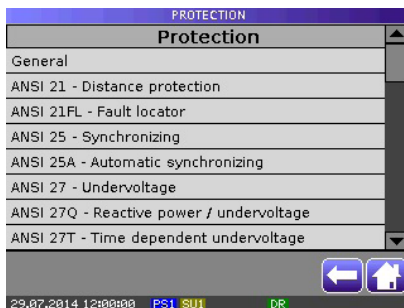

Protection

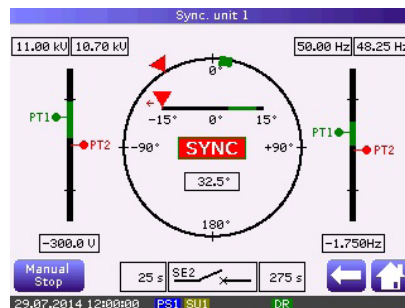

Synchronisation

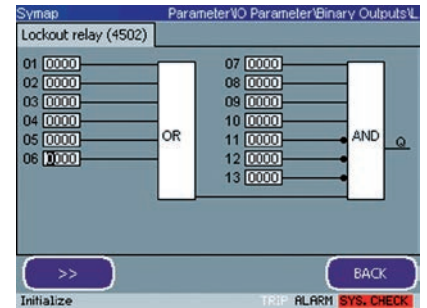

Programmable logic functions

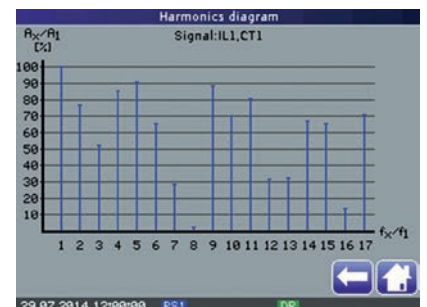

Harmonics

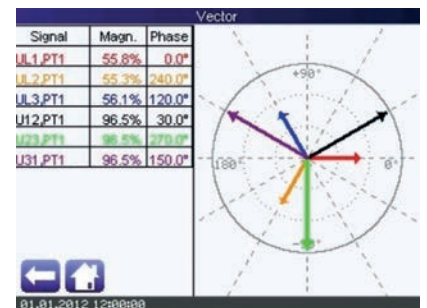

Vector diagram

Alarms and PLC

Alarms

The active alarm page is automatically activated when an alarm occurs. Up to 464 alarms can be set in the alarm list with up to 50 alarm groups. With every alarm it is possible to set the following:

- two trigger events
- alarm text
- conditions: OFF, Latched, Unlatched and No ACK
- text colour, LED colour and graphic LED colour
- blocking events
- alarm groups
- recording of alarms in recorder functions
- remote ACK
- acoustic alarm

Alarm

PLC

A large number of PLC logics and function blocks, user-programmable inputs and outputs and pre-defined logical event numbers allows the user to create powerful control and automation functions.

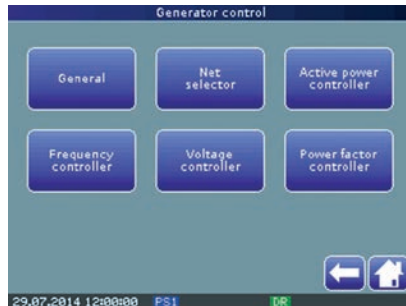

Generator control

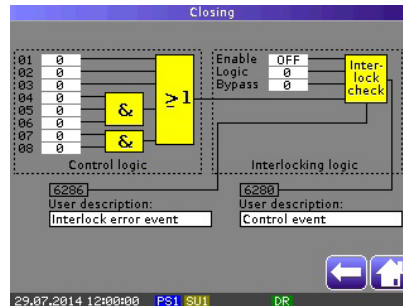

Closing conditions

Type	No. of available logic elements
AND/OR	500
NOT (inverter)	30
XOR (exclusive OR)	20
Flip-flop	20
Counter	20
Timer	80
Timer switch	20

Recorders

Event recorder

The event history saves up to 10.000 events by using the first-in-first-out (FIFO) principle. Each event provides information such as:

- the consecutive number
- the event number
- the event text
- date and time stamp



No.	Event	Text	Date	Time
0	6970	System booting	29.01.15	11:25:40.000
1	1004	Prot. param. set 1 acti	29.01.15	11:25:41.255
2	6810	Local mode	29.01.15	11:25:42.510
3	6801	User level 1	29.01.15	11:25:43.765
4	1000	Prot. param. set 1 acti	29.01.15	11:25:44.021
5	6970	System booting	29.01.15	11:25:45.276
6	6970	System booting	29.01.15	11:25:46.531
7	1004	Prot. param. set 1 acti	29.01.15	11:25:47.786
8	6810	Local mode	29.01.15	11:25:48.042
9	6801	User level 1	29.01.15	11:25:49.297
10	1000	Prot. param. set 1 acti	29.01.15	11:25:50.552

Event recorder

Events are recorded with a temporal resolution of 1 ms and will be displayed in chronological order. The latest event is on top of the event list.

Fault recorder

The fault recorder saves up to 1.000 recordings by using the first-in-first-out (FIFO) principle. The fault recorder records:

- all relevant file information (record number, trigger-event number, event text, date and time stamp)
- all available measuring values of current, voltage and frequency (depending on the SYMAP® Compact+ device variant) for one record

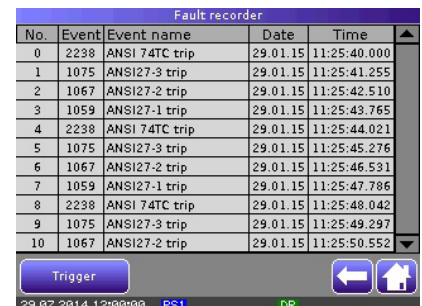

No.	Event	Event name	Date	Time
0	2238	ANSI 74TC trip	29.01.15	11:25:40.000
1	1075	ANSI27-3 trip	29.01.15	11:25:41.255
2	1067	ANSI27-2 trip	29.01.15	11:25:42.510
3	1059	ANSI27-1 trip	29.01.15	11:25:43.765
4	2238	ANSI 74TC trip	29.01.15	11:25:44.021
5	1075	ANSI27-3 trip	29.01.15	11:25:45.276
6	1067	ANSI27-2 trip	29.01.15	11:25:46.531
7	1059	ANSI27-1 trip	29.01.15	11:25:47.786
8	2238	ANSI 74TC trip	29.01.15	11:25:48.042
9	1075	ANSI27-3 trip	29.01.15	11:25:49.297
10	1067	ANSI27-2 trip	29.01.15	11:25:50.552

Fault recorder

Disturbance recorder

For the "disturbance recorder" function, the device is equipped with a volatile 20 MB RAM-memory to buffer the measuring data. That RAM-memory can be divided in up to 10 individual memory sections (buffers for recorded data). Each record will be automatically transferred to an 8 GB SD card. One record can be max. 63.31 s long.

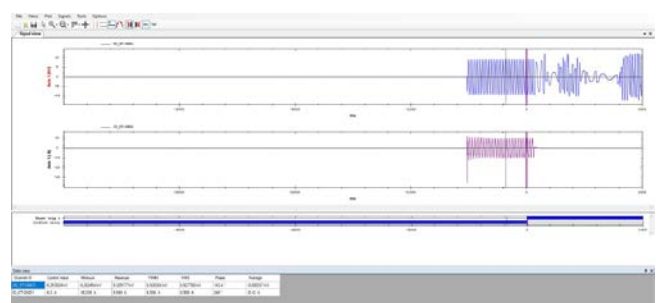

Communication

The total number of protocols that can be run simultaneously depends on the number of communication interfaces. The protocols under Ethernet interface Modbus TCP, IEC 61850 and IEC 60870-5 can always work simultaneously.

Communication interface

Standard port

- one USB-A (on front plate; for parameter setting)
- one Mini-USB (on the side for parameter setting)
- one CANBUS 0 (internal for detached HMI)
- one CANBUS 1 (factory protocol)
- one CANBUS 2 (factory protocol – optional)
- one RS485 port

Optional

- one fiber optic interface (line diff. protection / SCADA)
- one RS485 port (Modbus RTU or IEC 60870-5-103)
- one RJ45 service port (side)
- one RJ45 port (rear)
- two RJ45 ports (rear)
- one fiber optic port (rear)
- two fiber optic ports (rear)
- IRIG-B port



Protocols

- Profibus DP (option)
- Modbus RTU (standard)
- Modbus RTU redundant (option)
- Modbus TCP/IP (option)
- IEC 60870-5-103 (option)
- IEC 60870-5-104 (option)
- IEC 61850 Ed. 1 & Ed.2 (option)
- proprietary protocols

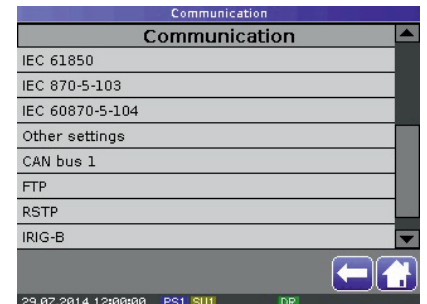

Communication

Network protocols and time synchronization

- RSTP (rapid spanning tree protocol)
- HSR (high-availability seamless redundancy), IEC 62439-3
- PRP (parallel redundancy protocol), IEC 62439-3
- SNTP (simple network time protocol)
- Hot standby-dual-homing
- IRIG-B

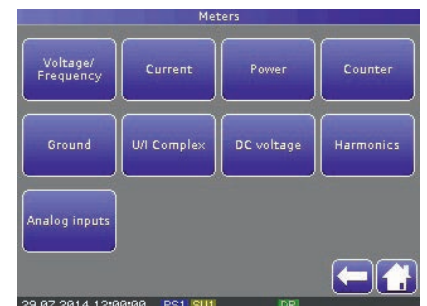

Meters

High-speed GOOSE

GOOSE

SYMAP®Compact with a number of virtual inputs and outputs allows to extend the use of GOOSE messages for various applications. Most important, it can provide additional safety and flexibility for a wide range of applications.

- 128 virtual inputs
- 128 virtual outputs

High-speed GOOSE

Under normal conditions, the response time for GOOSE messages incl. application time is approx. 2.7 ms. Under GOOSE performance testing conditions (abnormal conditions), the response time can be up to 1–1.5 ms longer in 99% of logs and in 1% a bit longer. However, messages are never lost and there is no further processing.

Note

The GOOSE performance test created by KEMA is the only test which shows the reliability of the GOOSE message in substations.

Application time + Communication time is approx. 2.7 ms

SYMAP®Compact+

SYMAP®Compact+



Communication time is approx. 0.5 ms

Extension Board System – EBS

The number of binary inputs and outputs can be increased with the Extension Board System (EBS). It consists of several board types with different functions. Each board is designed for DIN rail mounting according to standard DIN TS35. The maximum number of binary inputs and outputs via extension boards besides the SYMAP®Compact+ basic unit are:

- 50 EBS binary inputs
- 24 EBS binary outputs

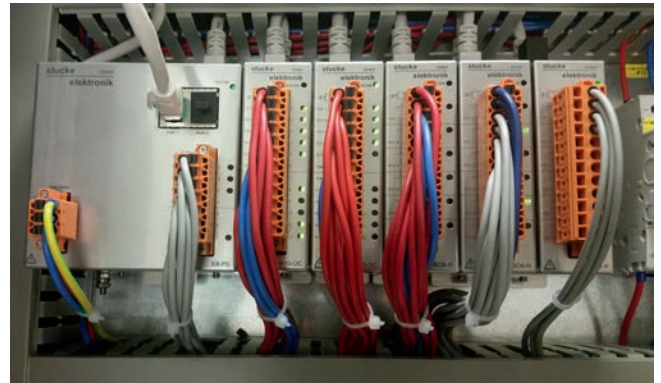

Service Interface

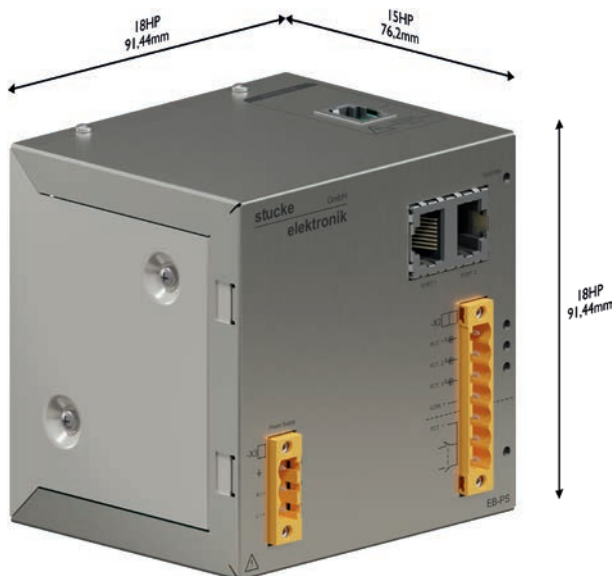
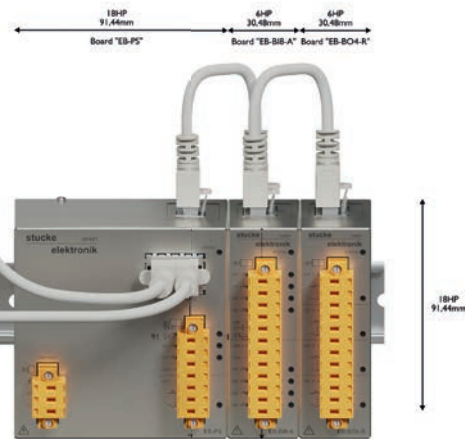

EB-PS

- power supply
- 1 system LED
- 3 RJ45 ports and 3 binary inputs with LED status
- 3 BIs (Un: 12/24/48/60/220 V DC; 110 V AC/DC; 230 V AC: parameterizable)

Housing dimensions (w × h × d): 91.5 × 91.5 × 76.2 mm

Extension Board System – EBS

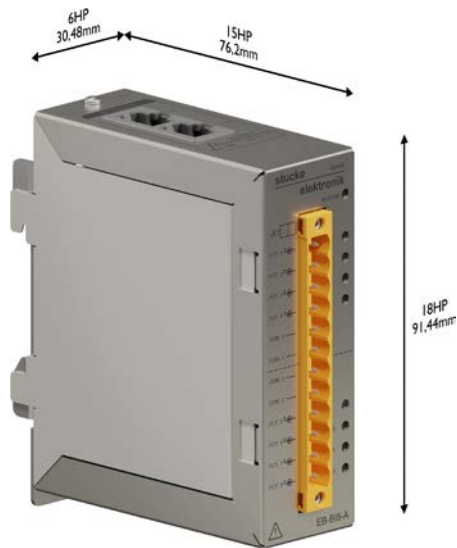

EB-BI8-A

- 8 binary inputs with LED status
- 2 independent voltage groups
- BIs (Un: 12/24/48/60/220V DC; 110V AC/DC; 230V AC: parameterizable)

Housing dimensions (w × h × d): 30.5 × 91.5 × 76.2 mm

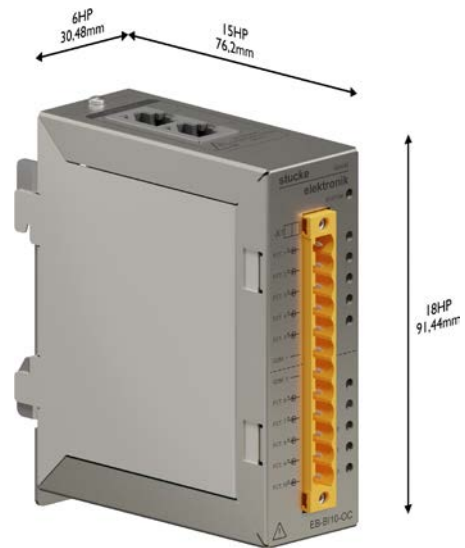

EB-BI10-OC

- 10 binary inputs (opto-couplers)
- 2 independent voltage groups
- BIs (Un: 12/24/48/60/220V DC; 110V AC/DC; 230V AC: parameterizable)

Housing dimensions (w × h × d): 30.5 × 91.5 × 76.2 mm

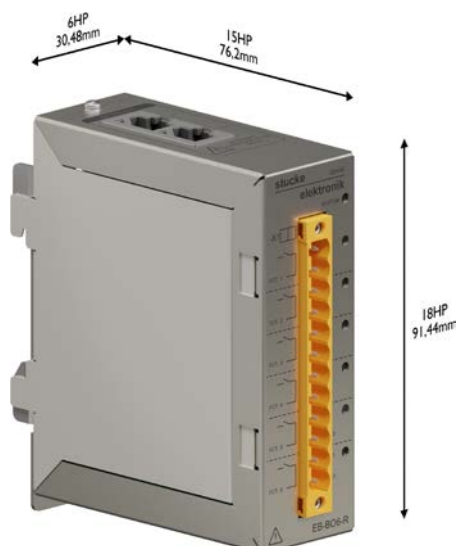

EB-B06-R-6

- 6 binary outputs (NO contacts)

Housing dimensions (w × h × d): 30.5 × 91.5 × 76.2 mm

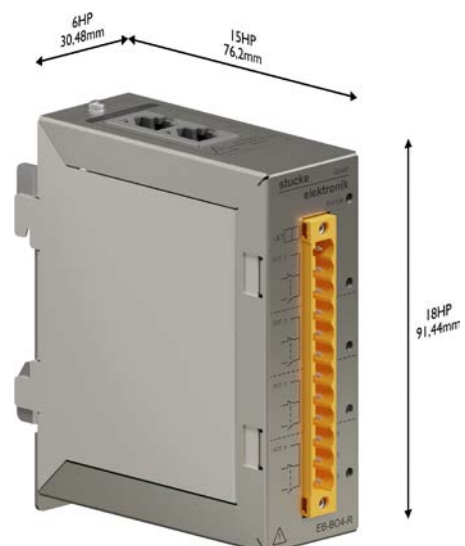

EB-B04-R-4

- 4 binary outputs (change-over contacts)

Housing dimensions (w × h × d): 30.5 × 91.5 × 76.2 mm

Dimensions

SYMAP® Compact+ has a compact housing with a small depth. The 90 mm depth including terminal plugs is suitable for almost any compartment, for both shallow and/or narrow compartments.

For retrofit projects it can save additional mechanical extensions and work when mounting and adjusting the device on the compartment door.

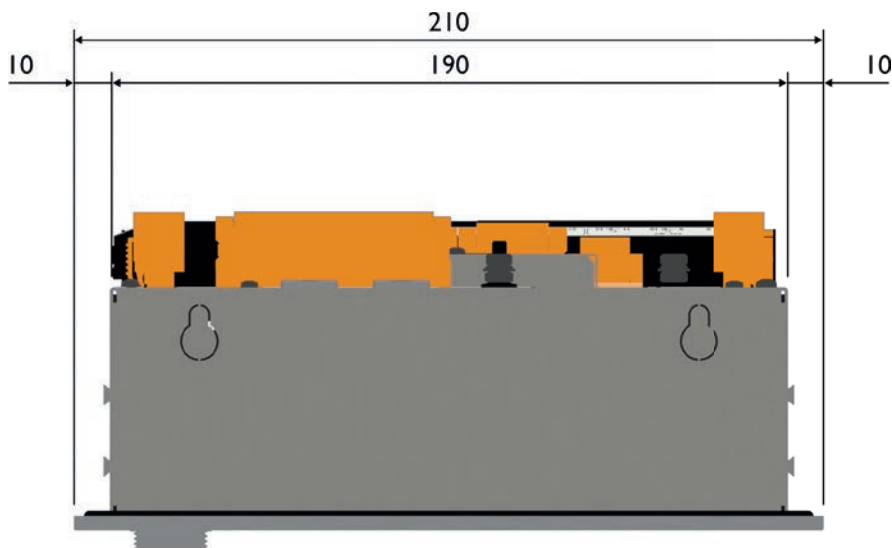
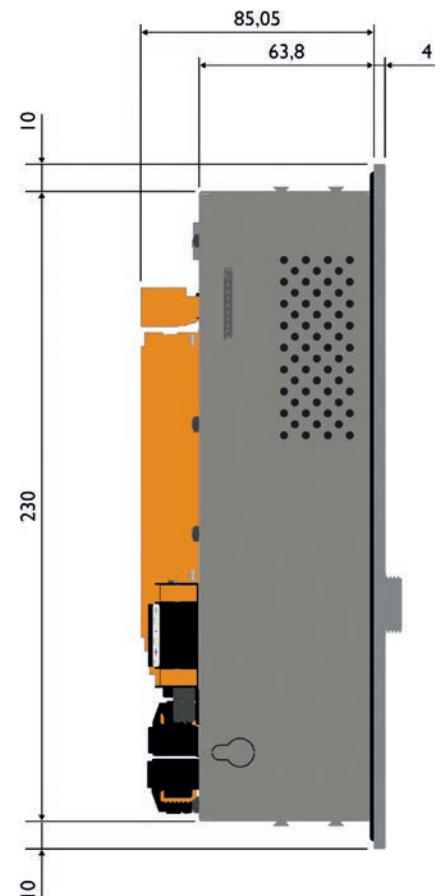
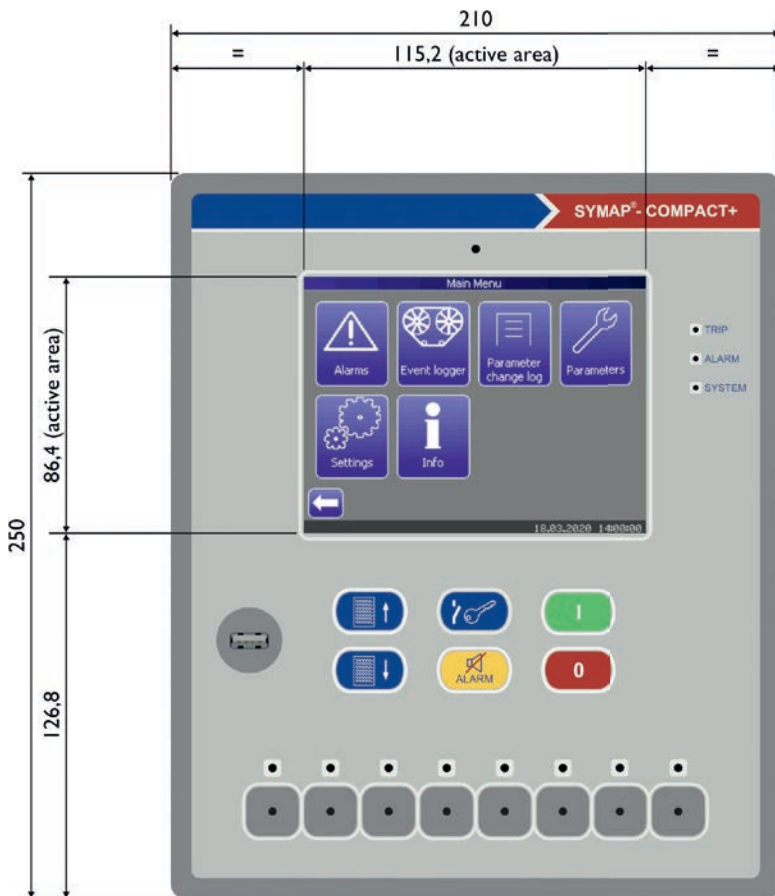

Dimensions:

- Width: 210 mm
- Height: 250 mm
- Depth: 90 mm (incl. terminal plugs)
- Weight: approx. 2.5 kg

Reliability and security

SYMAP®Compact+ has up to five microcontrollers for better performance and reliability. One microcontroller for measurement and protection functions (MU), one for control functions (CU), one for the graphic unit (GU), one for communication (ComU) and one for additional inputs and outputs (EBS). In the rare case of a broken touchscreen or damaged graphic unit, the device can still work, or, in case the robust communication card is in failure, protection and control will still work. If control or protection is in failure, the communication card can remotely send the alarm message that the device is in failure. The intermediate

communication between microcontrollers covers different sorts of watchdog functions and self-diagnostic tasks.

The device has two independent microcontrollers for Ethernet communication: one for communication protocols, network protocols and for service tasks such as parameterization, protection and event history download and one independent Ethernet port and microcontroller for service tasks such as parameterization, protection and event history download for isolated connection for better cyber security.

Five microcontrollers:

1. Control Unit – CU
2. Measurement and Protection functions – MU
3. Graphic Unit – GU
4. Communication Unit – ComU (optional)
5. Extension Board System (I/O) – EBS (optional)

Technical table

Description	Specification	
Design	flush-mounted housing for front panel cutout	
Display	graphical LC-display / touchscreen (320 × 240 pixel), screen refresh rate: 250 ms, cyclic	
Dimensions (w × h × d)	SYMAP®Compact+: 210 × 250 × 90 mm	
Front panel cutout (w × h)	SYMAP®Compact+: 192 × 232 mm	
Weight	SYMAP®Compact+: approx. 2.5 kg	
Installation position	vertical, +/-34°	
Power supply	according to ordering options: 24V DC or 48V DC or 60V DC or 110V AC/DC, 220V DC, 230V AC	
Power consumption	< 20 W	
Rechargeable battery	2 × 100 mAh, removable batteries, accessible on the housing rear	
External fuse	4A; "T-type"	
Boot phase	duration between switching on power supply to activation of device functions (full functionality) is 10 s	
Protection type	front panel back housing	IP54 (IEC 60529) IP20 (IEC 60529)
Cross section (max.)	spring-loaded terminals measuring input terminals (CT, PT)	max. 1.5 mm ² max. 6 mm ²

Capabilities

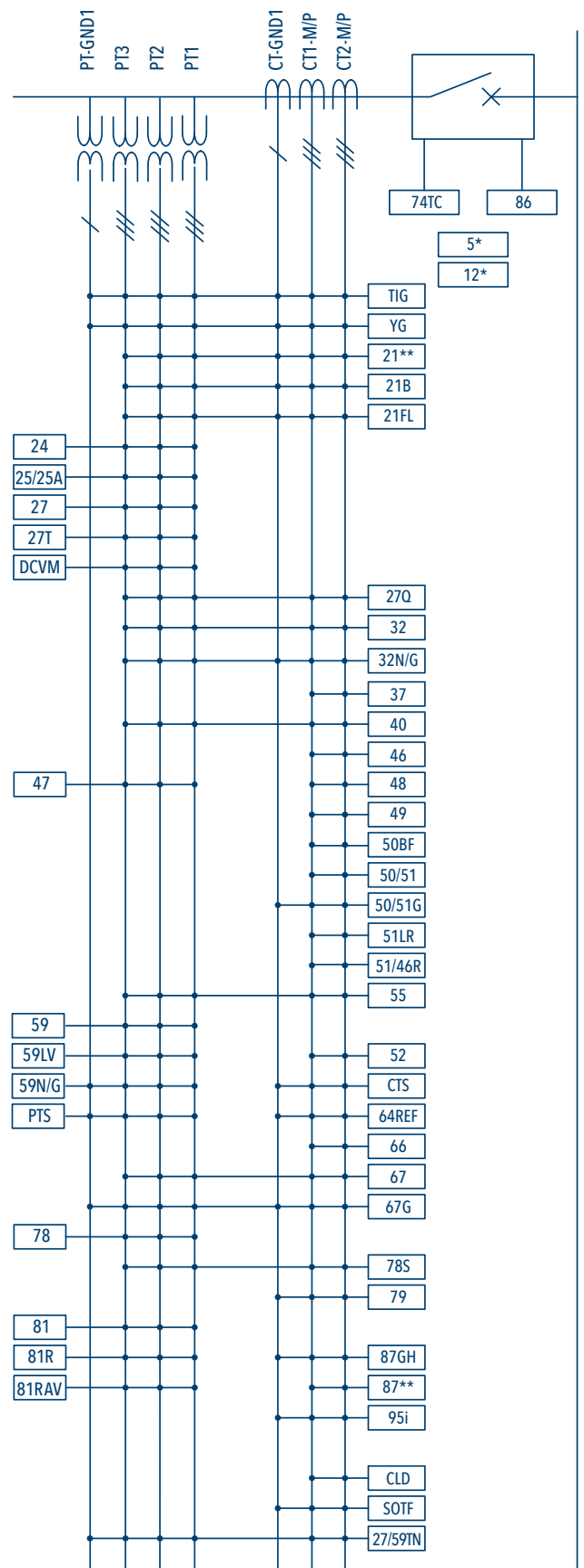
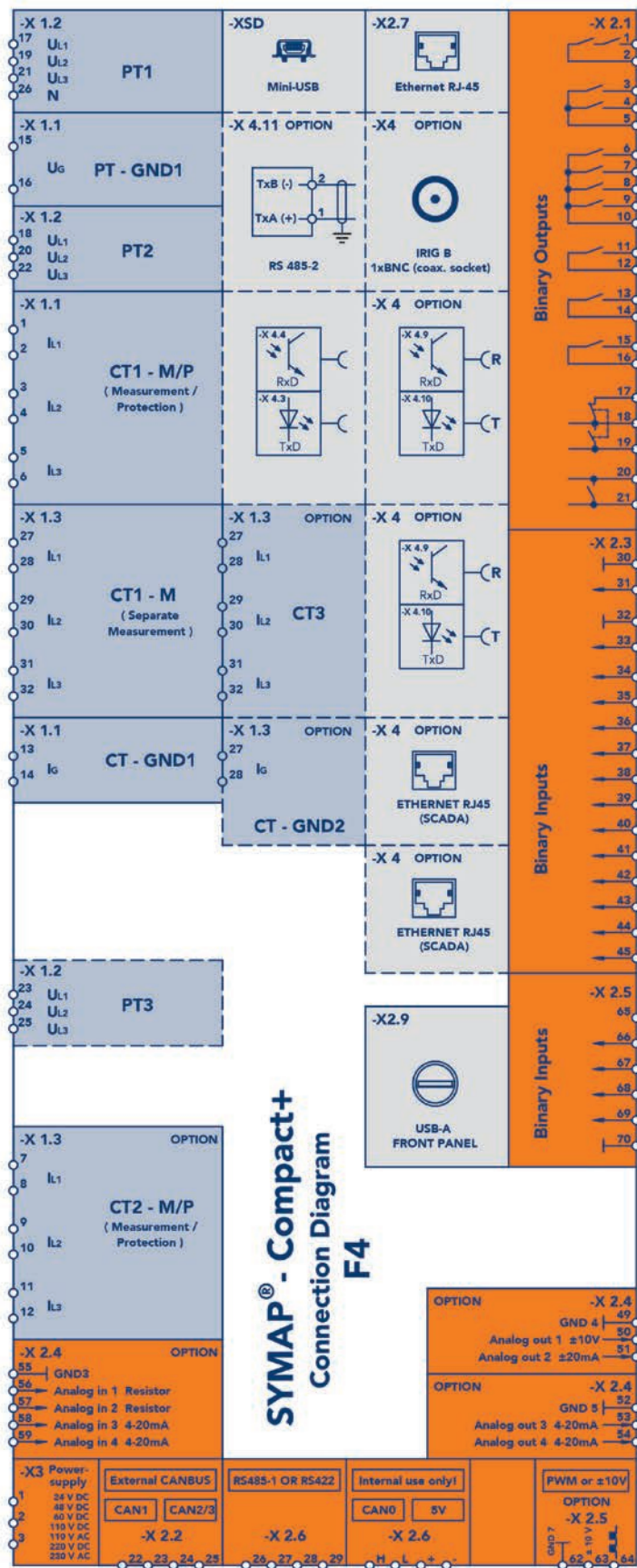

Compatibility tests – electromagnetic capability (EMC)

Description	Specification/test method	Standard															
Electromagnetic compatibility all tests were performed acc. to EN 60255-26	Conducted emission																
	Auxiliary power supply port	<table border="1"> <thead> <tr> <th rowspan="2">Frequency (MHz)</th> <th colspan="2">Limit Class A (dBuV)</th> </tr> <tr> <th>quasi-peak</th> <th>average</th> </tr> </thead> <tbody> <tr> <td>0.15 – 0.5</td> <td>79</td> <td>66</td> </tr> <tr> <td>0.5 – 5.0</td> <td>73</td> <td>60</td> </tr> <tr> <td>5.0 – 30.0</td> <td>73</td> <td>60</td> </tr> </tbody> </table>	Frequency (MHz)	Limit Class A (dBuV)		quasi-peak	average	0.15 – 0.5	79	66	0.5 – 5.0	73	60	5.0 – 30.0	73	60	EN 60255-25:2000 EN 55022:2010 EN 61000-6-4:2007
		Frequency (MHz)		Limit Class A (dBuV)													
			quasi-peak	average													
		0.15 – 0.5	79	66													
	0.5 – 5.0	73	60														
	5.0 – 30.0	73	60														
	Radiated emission																
	Fully operating device Note: radiated emission test above 1 GHz is not applicable since the highest internal frequency is less than 108 MHz	<table border="1"> <thead> <tr> <th>Frequency (MHz)</th> <th>Class A (at 3m) (dBuV/m)</th> </tr> </thead> <tbody> <tr> <td>30 – 230</td> <td>50</td> </tr> <tr> <td>230 – 1000</td> <td>57</td> </tr> </tbody> </table>	Frequency (MHz)	Class A (at 3m) (dBuV/m)	30 – 230	50	230 – 1000	57	EN 60255-25:2000 EN 55022:2010 EN 61000-6-4:2007								
		Frequency (MHz)	Class A (at 3m) (dBuV/m)														
		30 – 230	50														
	230 – 1000	57															
	Immunity to damped oscillatory wave																
	Damped oscillatory wave	Aux power supply, BIs, BOs, CTs and VTs	<table border="1"> <thead> <tr> <th>2.5 kV common mode</th> </tr> </thead> <tbody> <tr> <td>1 kV differential mode</td> </tr> </tbody> </table>	2.5 kV common mode	1 kV differential mode	EN 60255-21-1											
		2.5 kV common mode															
		1 kV differential mode															
	Communication	1 kV															
		0 kV															
	Slow oscillatory wave		EN 61000-4-18														
	Fast oscillatory wave																
	Immunity to electrostatic discharge																
	Discharge voltage - on both polarities for at least 1 s - at least 10 discharges at each point	Contact (level x) = 15 kV Air (level 4) = 15 kV	EN 60255-22-2:2008 EN 61000-4-2:1995 +A1:1999 + A2:2001 IEEE C37.90.3-2001														
	Immunity to radiated RF electromagnetic fields																
Frequency sweep	80-2700 MHz 80-1000 MHz (keying test)	EN 60255-22-3:2008 IEEE C37.90.2-2004 EN 61000-4-3:2006 +A1:2008															
Field strength	10/20 V/m 20 V/m (keying test)																
Modulation	1kHz sine wave, 80 %, AM modulation																
Frequency step	1 % of fundamental																
Dwell time	2 s																
ON/OFF period	2 s / 2 s																
Polarity of antenna	horizontal and vertical																
Test distance	3m for the test level 10V/m 1.8 m for the test level 20V/m																
Tested spot frequencies (MHz)	80, 160, 450, 900, 1850, 1890, 2150																

Compatibility tests – electromagnetic capability (EMC)

Description	Specification/test method		Standard	
Electromagnetic compatibility all tests were performed acc. to EN 60255-26	Immunity to fast transients (severity level 4)			
	Auxiliary power supply Functional earth Binary inputs Binary outputs CTs VTs	Repetition frequency	50 kHz and 100 kHz 2.5 kHz	EN 60255-22-4:2008 EN 60255-4-4:2004 IEEE C37.90.1-2002
		Burst duration	15ms at 2.5kHz and 5kHz, 0.75ms at 100kHz	
		Test duration	60 s at each polarity	
		Common mode	4 kV	
		Transverse mode	4 kV	
	Communication (over capacitive coupling clamp)	Repetition frequency	50 kHz and 100 kHz	
		Burst duration	15 ms at 2.5 kHz and 5 kHz, 0.75 ms at 100 kHz	
		Test duration	60 s at each polarity	
		Common mode	2 kV at 5 kHz and 100 kHz, 4 kV at 2.5 kHz	
		Transverse mode	0 kV	
	Immunity to surge voltages (severity level 4)			
	Auxiliary power supply functional Earth binary inputs Binary outputs CTs VTs Fully operating device Note: The operating time of instantaneous protection function elements shall be time delayed by 30 ms to prevent mal-operation	Common mode	4 kV	EN 60255-22-5:2002 EN 61000-4-5:2006
		Differential mode	2 kV	
	Communication	Screen	4kV	
	Immunity to conducted disturbance (severity level 3)			
	Frequency range	0.15 MHz-80 MHz		EN 60255-22-6:2001 EN 61000-4-6:2007
	Spot frequencies	27 MHz, 68 MHz		
	Field strength	10Vr ms		
	Modulation	1 kHz sine wave, 80 %, AM modulation		
Dwell time	2 s 10 s (spot frequencies)			
Immunity to electrical disturbance (class A)				
Binary inputs	Differential mode	150Vr ms	EN 60255-22-7:2003	
	Common mode	300Vr ms	EN 61000-4-16:1998	

Compatibility tests – electromagnetic capability (EMC)

Description	Specification/test method		Standard	
Electromagnetic compatibility all tests were performed acc. to EN 60255-26	Immunity to electromagnetic fields (severity level 5)			
	Field strength	100 A/m for 1 min and 1000 A/m for 3 s, 50/60 Hz	EN 61000-4-8:2010	
	Immunity to pulsed electromagnetic field (severity level 5)			
	Field strength	1000 A/m	EN 61000-4-9:1993 +A1:2001	
	No. of pulses	5 of each polarity		
	Time between pulses	10 s		
	Immunity to damped oscillatory magnetic field (severity level 5)			
	Frequency	100 kHz and 1 MHz	EN 61000-4-10:1998	
	Field strength	field strength 100 A/m (peak)		
	Repetition rate	40/s at 100 kHz and 400/s at 1 MHz		
	Test duration	2 s		
	Positions	X, Y, Z		
	Immunity to dips, short interruptions and AC ripple on the auxiliary voltage			
		Specification	Performance level	EN 60255-11:2010 EN 61000-4-11:2004 EN 61000-4-17:1997 EN 61000-4-29:2000
	Voltage dips (110 V DC power supply)	0 % (50 ms)	A	
		40 % (200 ms)	C	
		70 % (500 ms)	C	
	Voltage dips (230V AC power supply)	0 % (25 cycles)	A	
		40 % (10/12 cycles at 50/60 Hz)	C	
		70 % (10/12 cycles at 50/60 Hz)	C	
Voltage interruptions (110V DC)	0 % (5 s)	C		
Voltage interruptions (230V AC)	0 % (250/300 cycles at 50/60 Hz)	C		
Alternating component in DC voltage (DC power supply)	15 % of rated value of 100/120 Hz at rated 50/60 Hz)	A		
Gradual shutdown/startup (for DC power supply)	60 s shutdown, 5 min power off, 60 s startup	C		
Reversal of DC power supply polarity	1 min	(required C) performed at A		

CT and PT data

Description	Specification		
CT1 CT-GND1 CT2 CT-GND2	The following specifications of measuring accuracy are only valid for the set nominal frequency: 50 Hz/60 Hz		
	Deviation (magnitude)		
	Secondary nominal current In:	1A	
	Measuring ranges:	0.02...1 × In	deviation ≤ 0.5 % In
		1...10 × In	deviation ≤ 0.5 % of meas. value
		10...20 × In	deviation ≤ 1 % of meas. value
		20...32 × In	deviation ≤ 3 % of meas. value
	Temperature influence:	0...60°C	deviation 1 % In
	Frequency influence		
	- with adaption of sample time:	fn +/-5Hz	deviation ≤ x %/Hz
	- constant sample time:	fn +/-5Hz	deviation ≤ x %/Hz
	Harmonics influence:	20 % of 3rd or 5th harmonic	deviation ≤ 1 % In
	Secondary nominal current In:	5A	
	Measuring ranges:	0.02...1 × In	deviation ≤ 0.5 % In
		1...2 × In	deviation ≤ 0.5 % of meas. value
		2...20 × In	deviation ≤ 1 % of meas. value
		20...32 × In	deviation ≤ 3 % of meas. value
Temperature influence	0...60°C	deviation ≤ 1 % In	
Frequency influence			
- with adaption of sample time:	fn +/-5 Hz	deviation ≤ x %/Hz	
- constant sample time:	fn +/-5 Hz	deviation ≤ x %/Hz	
Harmonics influence:	20 % of 3rd or 5th harmonic	deviation ≤ 1 % In	
CT-GND (sensitive input)	Deviation (magnitude)		
	Total measuring range:	2...3000 mA	
	Measuring ranges:	2...100 mA	deviation ≤ 1mA
		100-2500 mA	deviation ≤ 1 % of meas. value
		2500...2800 mA	deviation ≤ 3 % of meas. value
	Temperature influence:	0...60°C	deviation ≤ 1 % In
	Frequency influence		
	- with adaption of sample time:	fn +/-5 Hz	deviation ≤ x %/Hz
- constant sample time:	fn +/-5 Hz	deviation ≤ x %/Hz	
Harmonics influence:	20 % of 3rd or 5th harmonic	deviation ≤ 1 % In	
CT1 CT2 CT-GND1 CT-GND2	Power consumption		
	1A inputs:	at 1 × In:	approx. 0.1 VA
		at 20 × In:	approx. 2.8 VA
		at 100 × In:	approx. 1.5 kVA
	5A inputs:	at 1 × In:	approx. 0.4 VA
		at 20 × In:	approx. 45 VA
		at 100 × In:	approx. 15 kVA
	Note: with a connecting cable (4 mm ² , length 2.5 m) and a 5A current transformer, the total load at 20 × In (5A) amounts to 227VA		
CT-GND1 (sensitive input)	CT-GND1 (sensitive input)		
	2...3000 mA:	at 100 mA:	approx. 0.007 VA
		at 3000 mA:	approx. 2.8 VA

CT and PT data

Description	Specification		
CT1 CT-GND1 CT2 CT-GND2	AC overcurrent proof		
	1A inputs:	at $250 \times I_n$:	for 10 ms (half-oscillation)
		at $100 \times I_n$:	up to 1 s
		at $30 \times I_n$:	up to 10 s
		at $20 \times I_n$:	continuous
	5A inputs:	at $250 \times I_n$:	for 10 ms (half-oscillation)
		at $100 \times I_n$:	up to 1 s
at $30 \times I_n$:		up to 10 s	
at $4 \times I_n$:		continuous	
CT-GND (sensitive input)	AC overcurrent proof		
	2...3000mA:	at 50A:	for 10 ms (half-oscillation)
		at 30A:	up to 1 s
		at 15A:	up to 10 s
at 3A:		continuous	
PT1 PT-GND1 PT2 PT3	Typical nominal voltages U_n (AC): 100V/110V/400V/(690V)		
	Measuring ranges (parameterizable PT input modes)		
	Low range:	0...200V AC	
	High range:	0...1000V AC	
	Caution: Product design accords to pollution degree 2, overvoltage category 3, for measurement phase-to-neutral voltages up to 300V RMS!		
	Deviation magnitude		
	Measuring ranges:	0.05...1.0 $\times U_n$:	deviation $\leq 0.9\%$ of U_n
		1.0...2.0 $\times U_n$:	deviation $\leq 0.4\%$ of U_n
	Power consumption		
	Load per phase:	at $U_n=100\text{ V}$:	approx. 0.1 VA
		at $U_n=200\text{ V}$:	approx. 0.2 VA
at $U_n=400\text{ V}$:		approx. 0.4 VA	
at $U_n=700\text{ V}$:		approx. 1 VA	
AC overvoltage proof			
	2000V:	up to 1 s	
	$2 \times U_n$:	continuous	

Power solutions. Worldwide.
Made in Germany. Since 1968.



Stucke Elektronik GmbH · Head Office of **stucke**GROUP
Merkurring 26 · 22143 Hamburg · Germany
+49 40 227468-0 · mail@stuckegroup.de
www.stuckeGROUP.com

